

TECHNICAL SPECIFICATIONS

The following pages detail the basic specifications of the products featured in this brochure. Further information can be found in the retail price list and of course your retailer will be able to assist you in planning your perfect bathroom

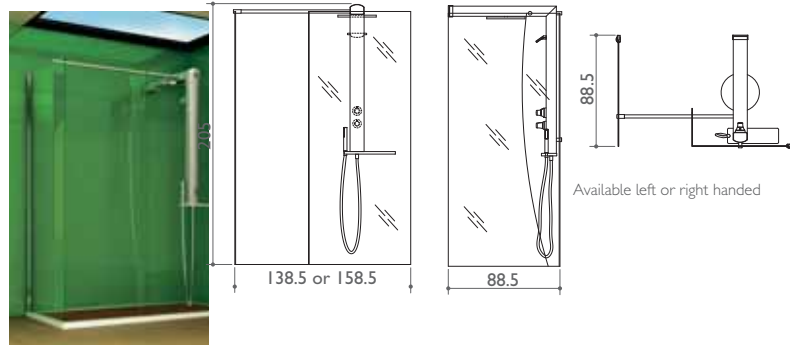

INTENSA FLAT FRONT WALK IN



DIMENSIONS			
EXTERNAL DIMENSIONS	Length	cm	140 / 160
	Width	cm	90
	Height	cm	205
NET WEIGHT	Kg		75.8

WATER			
Optimum turbo pressure	bar		2 – 3
Operating pressure	bar		1.5 – 5
WATER CONNECTIONS	Hot/cold water	1/2	
	Wall drainage column mm ø		40

INTENSA FLAT FRONT WITH PIVOT DOOR

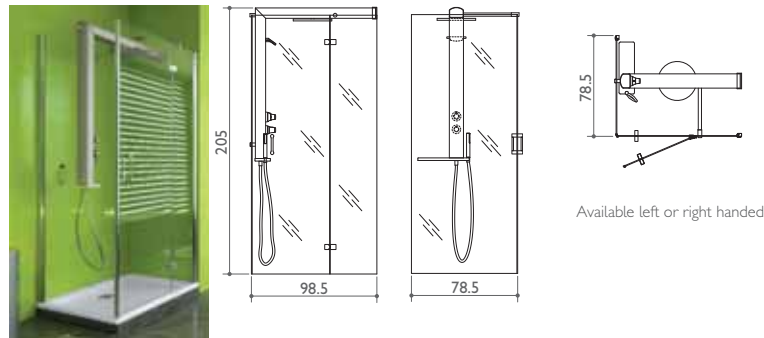

DIMENSIONS			
EXTERNAL DIMENSIONS	Length	cm	100
	Width	cm	80
	Height	cm	205
NET WEIGHT	Kg		68.7

WATER			
Optimum turbo pressure	bar		2 – 3
Operating pressure	bar		1.5 – 5
WATER CONNECTIONS	Hot/cold water	1/2	
	Wall drainage column mm ø		40

INTENSA BOW FRONT WITH PIVOT DOOR (120) OR WALK IN (140)

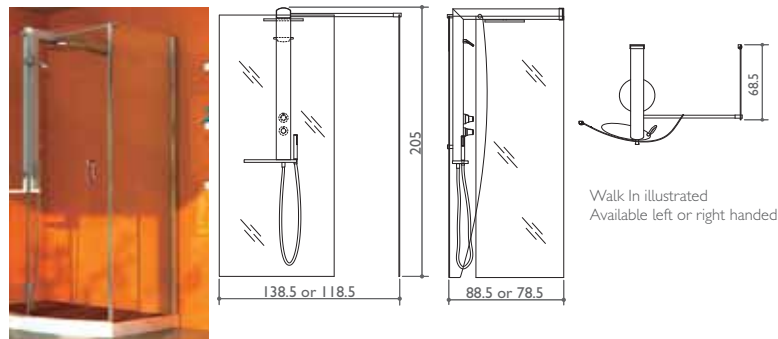

DIMENSIONS			
EXTERNAL DIMENSIONS	Length	cm	120 140
	Width	cm	70/80 70/90
	Height	cm	205 205
NET WEIGHT	Kg		73.2 65.7

WATER			
Optimum turbo pressure	bar		2 – 3
Operating pressure	bar		1.5 – 5
WATER CONNECTIONS	Hot/cold water	1/2	
	Wall drainage column mm ø		40

INTENSA TWIN COLUMN WITH PIVOT DOOR

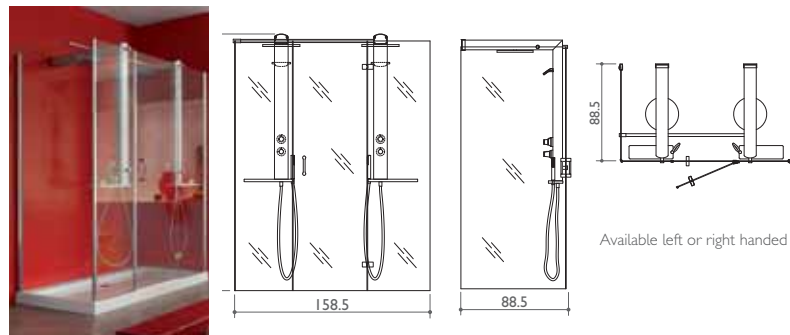

DIMENSIONS			
EXTERNAL DIMENSIONS	Length	cm	160
	Width	cm	90
	Height	cm	205
NET WEIGHT	Kg		104.4

WATER			
Optimum turbo pressure	bar		2 – 3
Operating pressure	bar		1.5 – 5
WATER CONNECTIONS	Hot/cold water	1/2	
	Wall drainage column mm ø		40

INTENSA BOW FRONT TRAY



Available with Duckboard

Depth of tray at waste: 5.9cm

DIMENSIONS			
EXTERNAL	Length	cm	120
	Width	cm	70/80
	Height	cm	3.5
	Weight	kg	20
	Length	cm	120
	Width	cm	70/80
	Height	cm	9
	Weight	kg	22
	Length	cm	140
	Width	cm	70/90
	Height	cm	3.5
	Weight	kg	25
	Length	cm	140
	Width	cm	70/90
	Height	cm	9
	Weight	kg	27

INTENSA FLAT FRONT TRAY



Available with Duckboard

Depth of tray at waste: 5.9cm

DIMENSIONS			
EXTERNAL	Length	cm	100
	Width	cm	80
	Height	cm	3.5
	Weight	kg	21
	Length	cm	100
	Width	cm	80
	Height	cm	9
	Weight	kg	23
	Length	cm	120
	Width	cm	90
	Height	cm	3.5
	Weight	kg	23
	Length	cm	120
	Width	cm	90
	Height	cm	9
	Weight	kg	25
	Length	cm	140
	Width	cm	90
	Height	cm	3.5
	Weight	kg	25
	Length	cm	140
	Width	cm	90
	Height	cm	9
	Weight	kg	28
	Length	cm	160
	Width	cm	90
	Height	cm	3.5
	Weight	kg	35
	Length	cm	160
	Width	cm	90
	Height	cm	9
	Weight	kg	38

PARAGON RECESS SLIDER AND TRAY

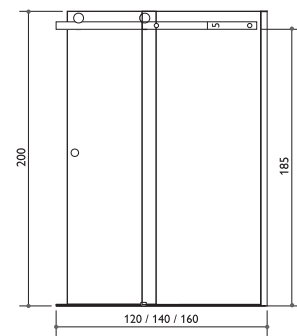

DIMENSIONS				
EXTERNAL DIMENSIONS	Length	cm	120 / 140 / 160	
	Width	cm	90	
	Height	cm	200	
NET WEIGHT		Kg	46 / 52 / 58	

PARAGON FLAT SLIDER FREESTANDING

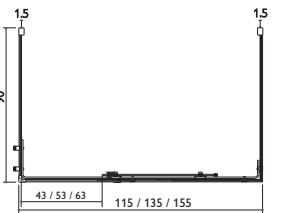
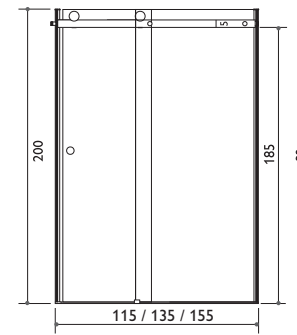

DIMENSIONS				
EXTERNAL DIMENSIONS	Length	cm	120 / 140 / 160	
	Width	cm	90	
	Height	cm	200	
NET WEIGHT		Kg	92 / 98 / 105	

Suitable for fitting on Intensa trays.

PARAGON FLAT SLIDER CORNER SITUATION

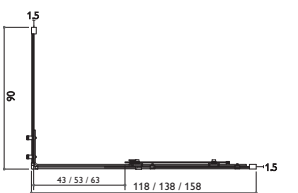
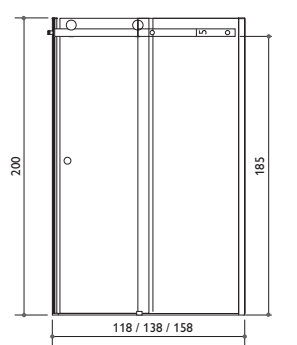

DIMENSIONS				
EXTERNAL DIMENSIONS	Length	cm	120 / 140 / 160	
	Width	cm	90	
	Height	cm	200	
NET WEIGHT		Kg	72 / 78 / 84	

Suitable for fitting on Intensa trays.

PARAGON CURVED SLIDER WITH TRAY

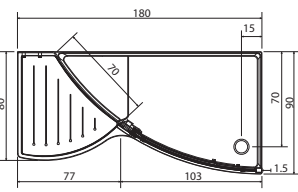
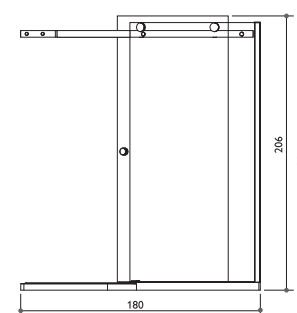

DIMENSIONS				
EXTERNAL DIMENSIONS	Length	cm	180	
	Width	cm	90	
	Height	cm	206	
NET WEIGHT		Kg	139	

PARAGON CURVED SLIDER WET ROOM

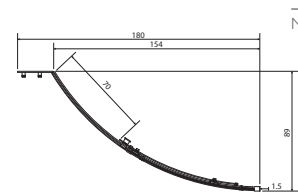
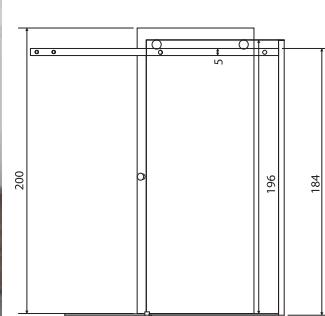

DIMENSIONS				
EXTERNAL DIMENSIONS	Length	cm	158	
	Width	cm	90	
	Height	cm	206	
NET WEIGHT		Kg	69	

AMARILYS HINGE DOOR RECESS AND CORNER

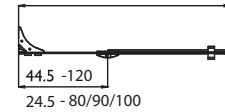
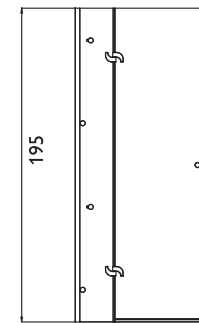

DIMENSIONS				
EXTERNAL DIMENSIONS	Width	cm	80/90/100/120	
	Height	cm	195	
NET WEIGHT		Kg	38 / 39 / 42.5 / 48.5	
ENTRY WIDTH		cm	46 / 56 / 60 / 66	

AMARILYS SIDE PANEL

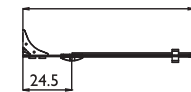
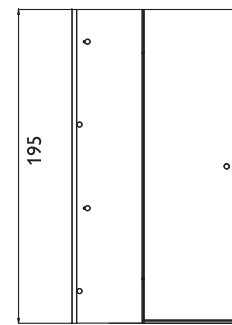

DIMENSIONS				
EXTERNAL DIMENSIONS	Width	cm	80/90/100	
	Height	cm	195	
NET WEIGHT		Kg	35 / 38.5 / 41.5	

AMARILYS QUADRANT

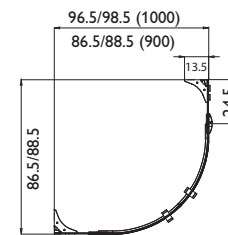
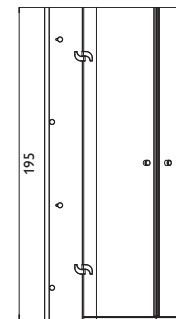

DIMENSIONS				
EXTERNAL DIMENSIONS	Width	cm	90/100	
	Height	cm	195	
	Radius	cm	55	
NET WEIGHT		Kg	36.2 / 38.2	

ASMARA BATH REPLACEMENT WALK IN

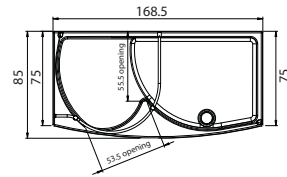
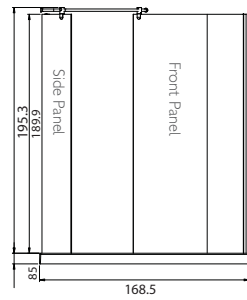

Right hand shown above
Left hand shown in photograph

DIMENSIONS

EXTERNAL DIMENSIONS	Length	cm	168.5
	Width	cm	75
	Height with tray	cm	203.8
	Height, tray & panel	cm	214.8

Suitable for Corner Installation only.

ASMARA QUADRANT

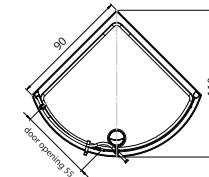
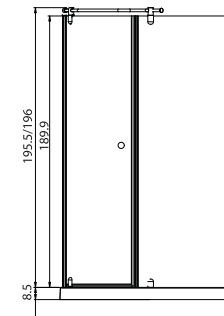

Left hand shown above

DIMENSIONS

EXTERNAL DIMENSIONS	Length	cm	110
	Width	cm	90
	Height with tray	cm	204.5
	Height, tray & panel	cm	215.5

ASMARA OFFSET QUADRANT

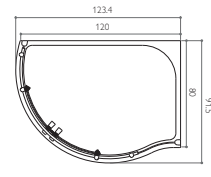
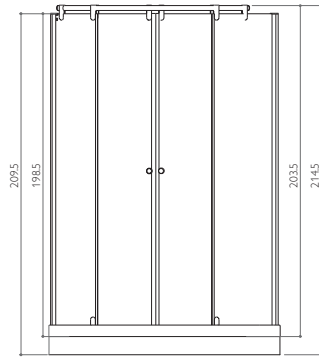

Right hand shown above

DIMENSIONS

EXTERNAL DIMENSIONS	Length	cm	123
	Width	cm	91.5
	Height with tray	cm	203.5
	Height, tray & panel	cm	214.5
ENTRY WIDTH		cm	55

ASMARA PIVOT AND CURVED SIDE PANEL

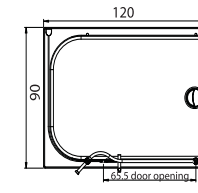
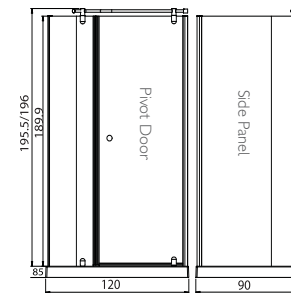

Right hand shown above

DIMENSIONS

EXTERNAL DIMENSIONS	Length	cm	120
	Width	cm	90
	Height with tray	cm	204.5
	Height, tray & panel	cm	215.5

ASMARA SLIDING DOOR QUADRANT

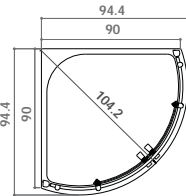
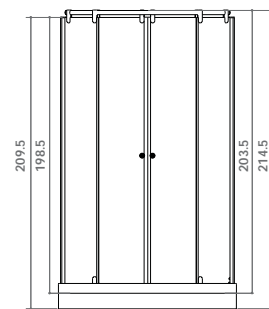

DIMENSIONS

EXTERNAL DIMENSIONS	Length	cm	94.4
	Width	cm	90
	Height with tray	cm	203.5
	Height, tray & panel	cm	214.5
ENTRY WIDTH		cm	55

ASMARA LUXURY CURVED GLASS WALK IN

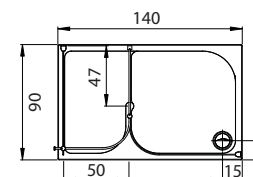
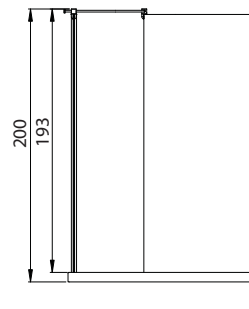

Right hand shown above

DIMENSIONS

EXTERNAL DIMENSIONS	Length	cm	140
	Width	cm	90
	Height with tray	cm	200
	Height, tray & panel	cm	211

ASMARA OFFSET QUADRANT PIVOT

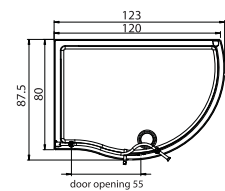
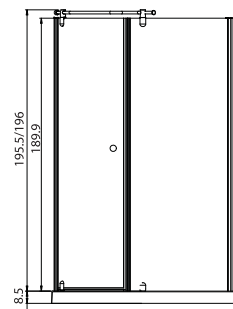

Left hand shown above

DIMENSIONS

EXTERNAL DIMENSIONS	Length	cm	123
	Width	cm	87.5
	Height with tray	cm	204.5
	Height, tray & panel	cm	215.5

ASMARA BOW FRONT SLIDER

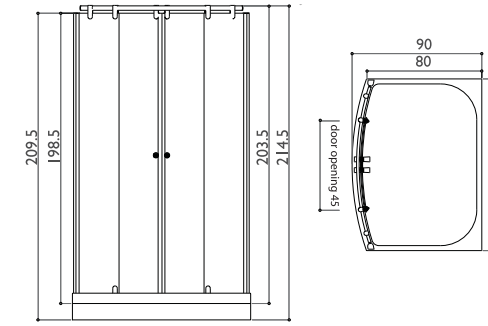

DIMENSIONS

EXTERNAL DIMENSIONS	Length	cm	120
	Width	cm	80 (90)
ENTRY WIDTH	Height with tray	cm	203.5
	Height, tray & panel	cm	214.5
		cm	45

ASMARA PIVOT AND SIDE PANEL

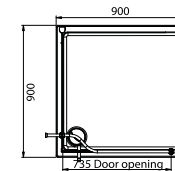
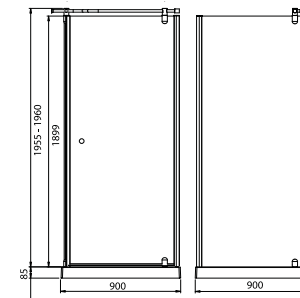

Right hand shown above
Recess version available

DIMENSIONS

EXTERNAL DIMENSIONS	Length	cm	76 / 80 / 90
	Width	cm	76 / 80 / 90
ENTRY WIDTH	Height with tray	cm	204.5
	Height, tray & panel	cm	215.5

ASMARA RECESS PIVOT WITH INFILL PANEL

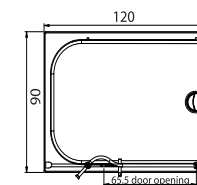
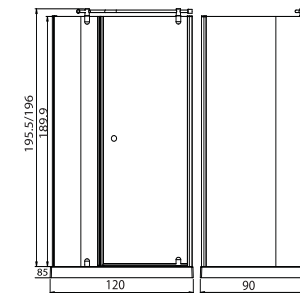

Right hand shown above

DIMENSIONS

EXTERNAL DIMENSIONS	Length	cm	120
	Width	cm	90
ENTRY WIDTH	Height with tray	cm	204.5
	Height, tray & panel	cm	215.5

YNVENTA FLAT PANELS

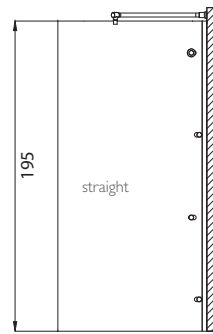

DIMENSIONS				
EXTERNAL DIMENSIONS	Length	cm	74 / 84 / 94	
	Height	cm	195	
NET WEIGHT		Kg	35 / 38.5 / 41.5	

ENSIGN BI-FOLD

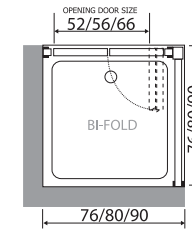
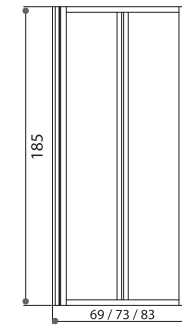

DIMENSIONS				
DOOR EXTERNAL DIMENSIONS	Length	cm	76/80/90	
	Height	cm	185	
SIDE PANEL OPTIONS	Length	cm	76/80/90	
	Height	cm	185	

YNVENTA CURVED PANEL

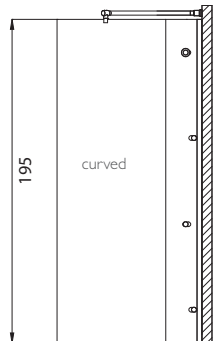

DIMENSIONS				
EXTERNAL DIMENSIONS	Length	cm	89.2	
	Width	cm	32.7	
	Height	cm	195	
NET WEIGHT		Kg	42	

ENSIGN OFFSET QUADRANT

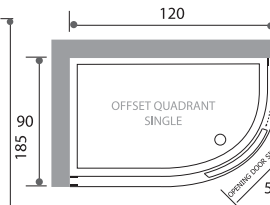
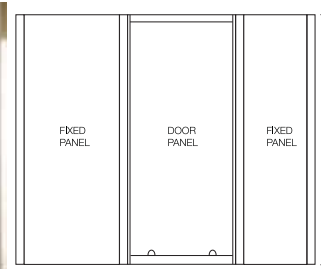

DIMENSIONS				
EXTERNAL DIMENSIONS	Length	cm	120	
	Width	cm	90	
	Height	cm	185	

Left hand shown

NB: 55cm radius ROKLITE tray required.

Also available in double door option.

YNVENTA CURVED PANEL WITH DEFLECTOR PANEL

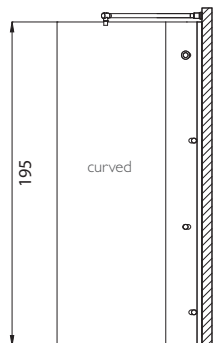

DIMENSIONS				
EXTERNAL DIMENSIONS	Length	cm	90	
	Width	cm	90	
	Height	cm	195	
NET WEIGHT		Kg	57	

ENSIGN STRAIGHT SLIDER

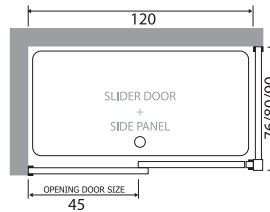
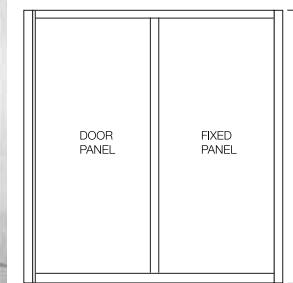

DIMENSIONS				
DOOR EXTERNAL DIMENSIONS	Length	cm	120	
	Height	cm	185	
SIDE PANEL OPTIONS	Length	cm	76/80/90	
	Height	cm	185	

YNVENTA FLAT PANEL WITH DEFLECTOR PANEL

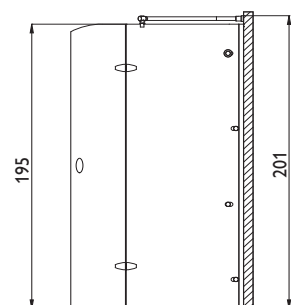

DIMENSIONS				
EXTERNAL DIMENSIONS	Length	cm	110 / 120 / 130	
	Height	cm	195	
NET WEIGHT		Kg	50 / 53.5 / 56.5	

ENSIGN BOW SLIDER

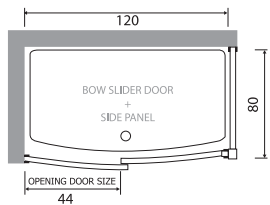
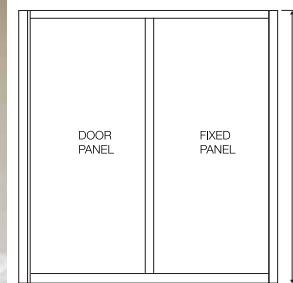

DIMENSIONS				
DOOR EXTERNAL DIMENSIONS	Length	cm	120	
	Height	cm	185	
SIDE PANEL OPTIONS	Length	cm	80	
	Height	cm	185	

NB: Bowed rectangular tray required.



ENSIGN BOW PIVOT

ENSIGN BOW PIVOT

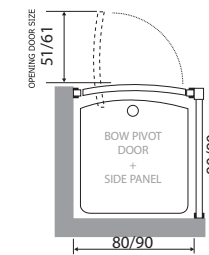
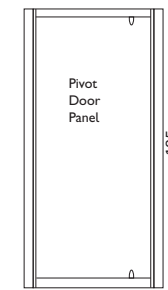

DIMENSIONS

DOOR			
EXTERNAL DIMENSIONS	Length	cm	80/90
	Height	cm	185
SIDE PANEL			
OPTIONS	Length	cm	80/90
	Height	cm	185

NB: Bow square tray required

ENSIGN STRAIGHT PIVOT

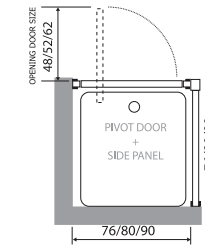
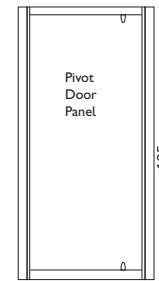

DIMENSIONS

DOOR			
EXTERNAL DIMENSIONS	Length	cm	76/80/90
	Height	cm	185
SIDE PANEL			
OPTIONS	Length	cm	76/80/90
	Height	cm	185

ENSIGN QUADRANT

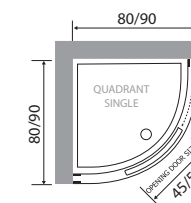
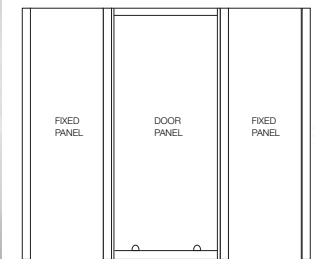

DIMENSIONS

EXTERNAL DIMENSIONS			
	Length	cm	80/90
	Width	cm	80/90
	Height	cm	185

NB: 55cm radius ROKLITE tray required.

Also available in double door option

ENSIGN CORNER ENTRY

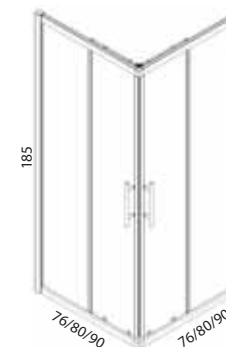

DIMENSIONS

EXTERNAL DIMENSIONS			
	Length	cm	76/80/90
	Width	cm	76/80/90
	Height	cm	185

VERSA LINK SHOWER BATH



Available left or right handed

Right hand shown

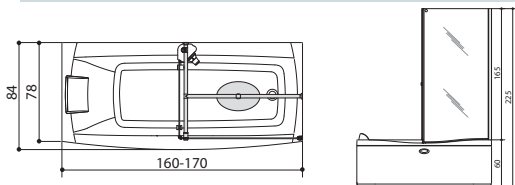

DIMENSIONS

EXTERNAL DIMENSIONS
Length 170 • Width 78cm • Height 60cm (70cm at widest point)

INSIDE DIMENSIONS
Length at top edge 150cm • Length at fittings 120cm
Central width at top edge 64cm • Bath net weight 100kg

ELECTRICAL GROUP JP12 –Volts 220 / 240 • Ampere 3.5 (10.5)
ELECTRIC PUMP – 0.7HP (power absorption) 0.7kW 50Hz

WATER Water volume (at the overflow level) 200 Litres

WATER CONNECTIONS
Hot/cold water 1/2"
Distributor/diverter 1/2"
DRAIN 1 1/2"

VERSA



Available left or right handed

Left hand shown

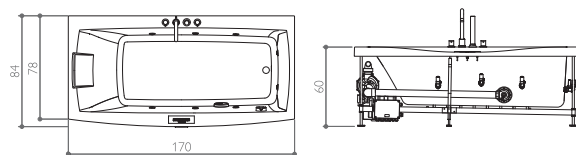

Non-Whirlpool option also available

DIMENSIONS

EXTERNAL DIMENSIONS
Length 170cm • Width 78 (84cm at widest point) • Height 60cm

INSIDE DIMENSIONS
Length at top edge 150cm • Length at fittings 120cm
Central width at top edge 64cm

Bath net weight 64kg • Load on floor (at the overflow level) 225 Kg/m²

ELECTRICAL GROUP JP12 –Volts 220 / 240 • Ampere 3.5 (10.5)
ELECTRIC PUMP – 0.7HP (power absorption) 0.7kW / 50Hz

WATER Water volume (at the overflow level) 240 Litres
Average water quantity for hydromassage 160 Litres

WATER CONNECTIONS
Hot/cold water 1/2"
Distributor/diverter 1/2"
DRAIN 1 1/2"

INVITA

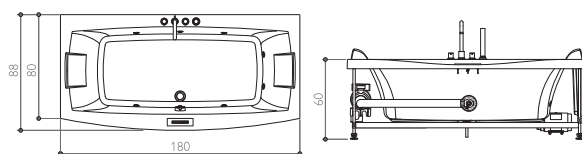

Non-Whirlpool option also available

DIMENSIONS

EXTERNAL DIMENSIONS
Length 180cm • Width 80 (88cm at widest point) • Height 60cm

INSIDE DIMENSIONS
Length at top edge 168cm • Length at fittings 127cm
Central width at top edge 58cm • Bath net weight 63kg

Load on floor (at the overflow level) 214 Kg/m²

ELECTRICAL GROUP JP12 –Volts 220 / 240 • Ampere 3.5 (10.5)
ELECTRIC PUMP – 0.7HP (power absorption) 0.7kW 50Hz

WATER Water volume (at the overflow level) 260 Litres
Average water quantity for hydromassage 160 Litres

WATER CONNECTIONS
Hot/cold water 1/2"
Distributor/diverter 1/2"
DRAIN 1 1/2"

UMA



Handing as shown

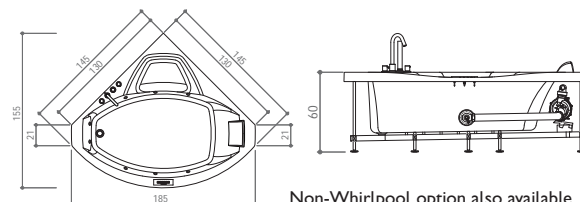

Non-Whirlpool option also available

DIMENSIONS

EXTERNAL DIMENSIONS
Length 130/145cm • Width 130/145cm • Height 60cm

INSIDE DIMENSIONS
Length at top edge 155cm • Length at fittings 125cm
Central width at top edge 87cm

Bath net weight 72kg • Load on floor (at the overflow level) 246 Kg/m²

ELECTRICAL GROUP JP12 –Volts 220 / 240 • Ampere 3.5 (10.5)
ELECTRIC PUMP – 0.7HP (power absorption) 0.7kW / 50Hz

WATER Water volume (at the overflow level) 300 Litres
Average water quantity for hydromassage 175 Litres

WATER CONNECTIONS
Hot/cold water 1/2"
Distributor/diverter 1/2"
DRAIN 1 1/2"

RIVELA



Available left or right handed

Left hand shown

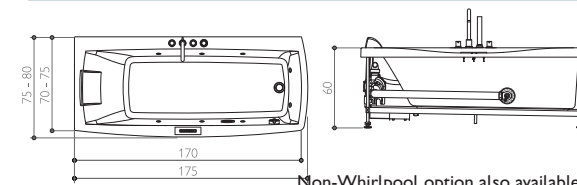

Non-Whirlpool option also available

DIMENSIONS

EXTERNAL DIMENSIONS
Length 170cm • Width 70 (75cm at widest point) • Height 60cm
Length 170cm • Width 75 (80cm at widest point) • Height 60cm

INSIDE DIMENSIONS
(70)cm – Length at top edge 175cm • Length at fittings 130cm
Central width at top edge 57cm • Bath net weight 59kg
(75)cm – Length at top edge 175cm • Length at fittings 130cm
Central width at top edge 62cm • Bath net weight 60kg

Load on floor (at the overflow level) (70)cm – 222 Kg/m² / (75)cm – 219 Kg/m²

ELECTRICAL GROUP JP12 –Volts 220 / 240 • Ampere 3.5 (10.5)
ELECTRIC PUMP – 0.7HP (power absorption) 0.7kW 50Hz

WATER Water volume (at the overflow level) 220 Litres (70cm)
235 Litres (75cm)
Average water quantity for hydromassage 150 Litres (70cm)
175 Litres (75cm)

WATER CONNECTIONS
Hot/cold water 1/2"
Distributor/diverter 1/2"
DRAIN 1 1/2"

TURCHINO

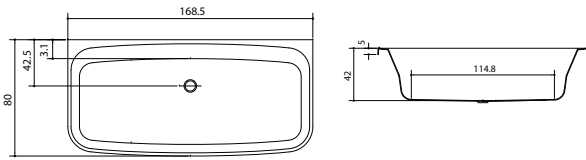

DIMENSIONS
EXTERNAL DIMENSIONS
Length 170cm • Width 80cm • Height 42cm

PAVIA

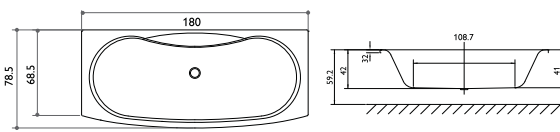

DIMENSIONS
EXTERNAL DIMENSIONS
Length 180cm • Width 70cm (80cm at widest point) • Height 42cm

VENETO

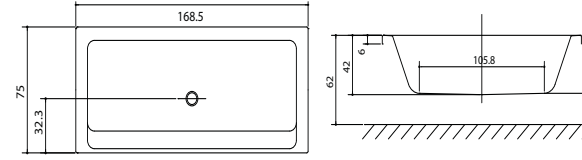

DIMENSIONS
EXTERNAL DIMENSIONS
Length 170cm • Width 75cm • Height 42cm

ARAGONA



80 Litres

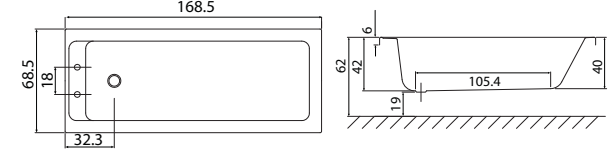

DIMENSIONS
EXTERNAL DIMENSIONS
Length 170cm • Width 70cm • Height 42cm

AUGUSTO

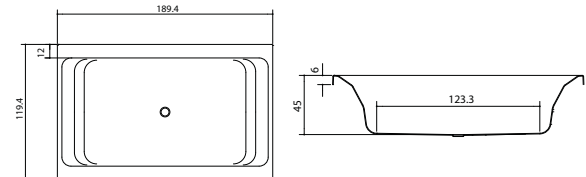

DIMENSIONS
EXTERNAL DIMENSIONS
Length 190cm • Width 120cm • Height 45cm

GRADO

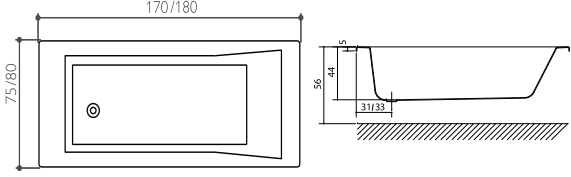

DIMENSIONS
EXTERNAL DIMENSIONS
Length 170/180cm • Width 75/80cm • Height 44cm

RIETI



72 Litres

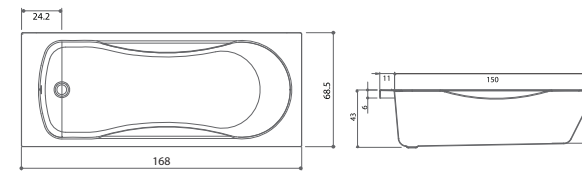

DIMENSIONS
EXTERNAL DIMENSIONS
Length 170cm • Width 70cm • Height 42cm

ALVITO



79/67 Litres

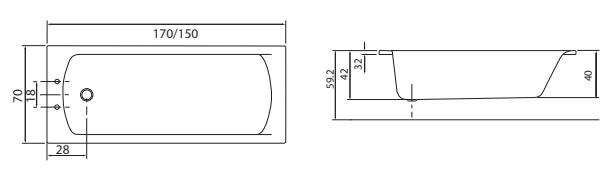

DIMENSIONS
EXTERNAL DIMENSIONS
Length 170/150cm • Width 70cm • Height 42cm

ALBANO

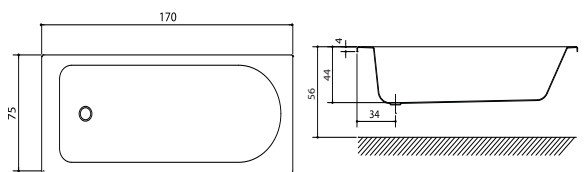

DIMENSIONS
EXTERNAL DIMENSIONS
Length 170cm • Width 75cm • Height 44cm

ANDRANO

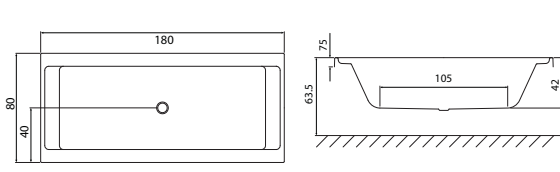

DIMENSIONS
EXTERNAL DIMENSIONS
Length 180cm • Width 80cm • Height 42cm

MANTOVA CORNER

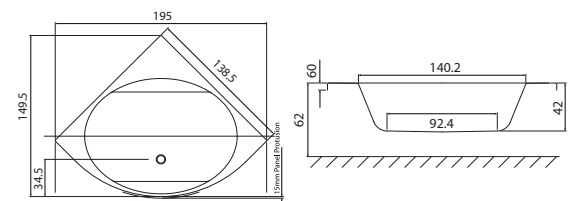

DIMENSIONS
EXTERNAL DIMENSIONS
Length 140cm • Width 140cm • Height 42cm

ARBA OFFSET CORNER



Available left or right handed Right hand shown 78 Litres

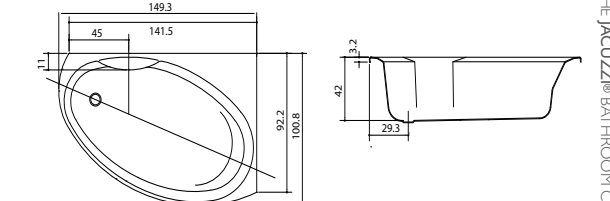

DIMENSIONS
EXTERNAL DIMENSIONS
Length 150cm • Width 100cm • Height 42cm

MERANO SHOWER BATH

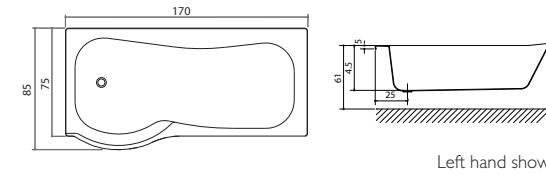

DIMENSIONS

EXTERNAL DIMENSIONS
Length 170cm • Width 75 (85cm at widest point) • Height 61cm

TABIANO SHOWER BATH

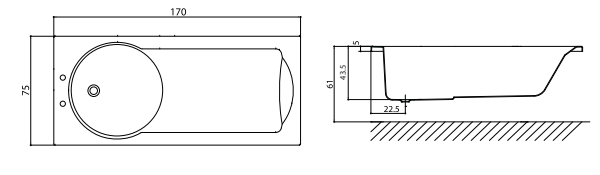

DIMENSIONS

EXTERNAL DIMENSIONS
Length 170cm • Width 75cm • Height 43cm

CALABRIA SHOWER BATH

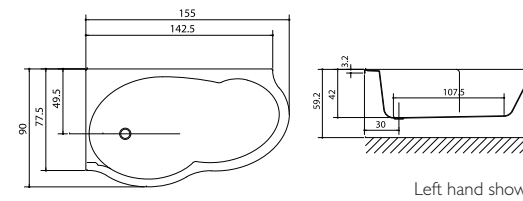

DIMENSIONS

EXTERNAL DIMENSIONS
Length 155cm • Width 77.5cm (90cm at widest point) • Height 42cm

ALVITO SHOWER BATH

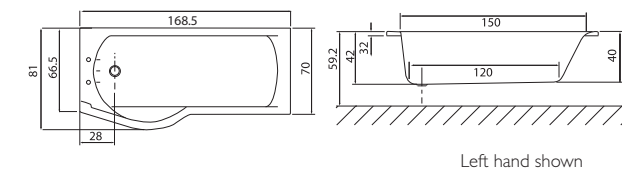

DIMENSIONS

EXTERNAL DIMENSIONS
Length 170cm • Width 70cm (81cm at widest point) • Height 42cm

ALESSANO SHOWER BATH

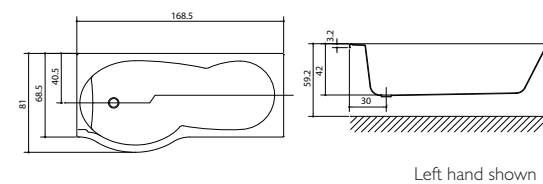

DIMENSIONS

EXTERNAL DIMENSIONS
Length 170cm • Width 70cm (81cm at widest point) • Height 42cm



The Water Efficiency logo shown within this brochure is a mark issued by the Bathroom Manufacturers Association to highlight those products that when installed, use less water than other products available in the market. Baths and whirlpool baths containing 80 litres of water or less, at 40% of the total volume when filled to the overflow qualify to bear this mark.

YNCONTRA SINGLE SCREEN WITH DEFLECTOR

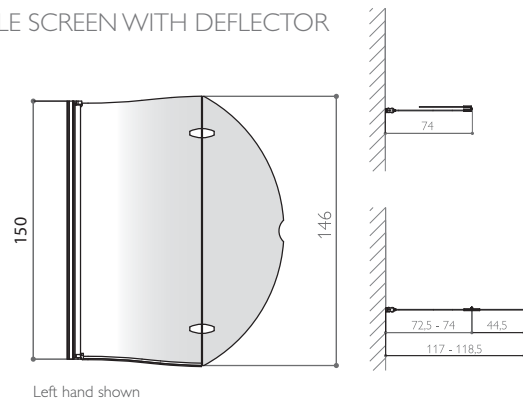

Left hand shown

DIMENSIONS

Width 117/118.5cm
Height 140/146cm

For use with Versa, Rivela and Invita baths

Also available in double door option

THEOS SINGLE AND DOUBLE

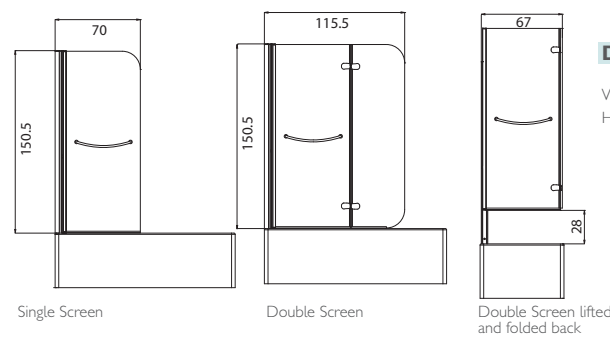

Single Screen

Double Screen

Double Screen lifted and folded back

DIMENSIONS

Width 70/115.5cm
Height 150.5cm

MERANO SINGLE CURVED SCREEN

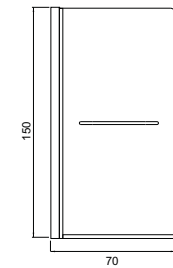

DIMENSIONS

Width 70cm
Height 150cm

For use with Merano Shower Bath

NEVADA SINGLE AND SINGLE WITH INFILL

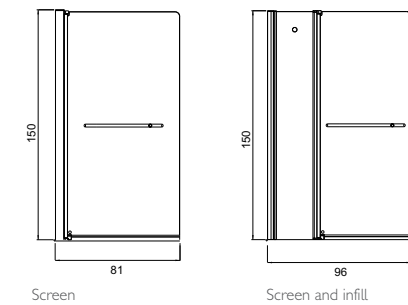

Screen

Screen and infill

DIMENSIONS

Width 81cm
Width with Infill 96cm
Height 150cm

ALLUMIERE CURVED SCREEN

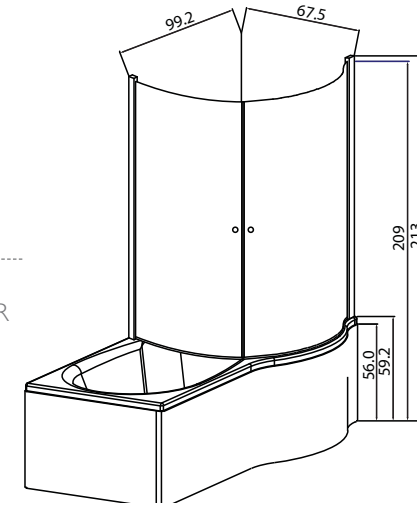

DIMENSIONS

Height 150cm

For use with Calabria and Alessano Shower Baths

ALLUMIERE WITH PIVOT DOOR



DIMENSIONS

Height 150cm

For use with Alessano Shower Bath

ALMANY SCREEN WITH SHELVING

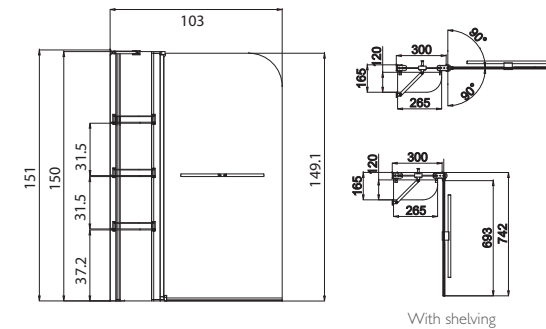

DIMENSIONS

Width 103cm
Height 151cm

With shelving

NEVADA SINGLE AND SINGLE WITH INFILL

ALVITO CURVED SCREEN

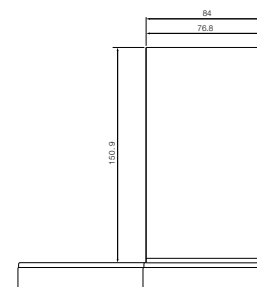

DIMENSIONS

Width 84cm
Height 150.9cm

For use with Alvito Shower Bath



ALMANY OVER BATH SCREEN

OVER BATH SCREENS

PASSIONATA

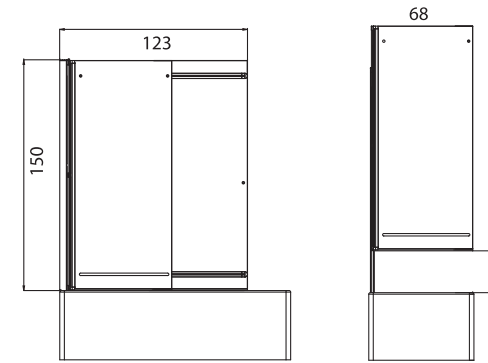

TECHNICAL SPECS

DIMENSIONS

Width 72.5cm adjusts to 123cm
Height 150cm

Pivoting panel has rising hinge which lifts 28mm,
making movement easier and avoids wear on seals

HELIOS

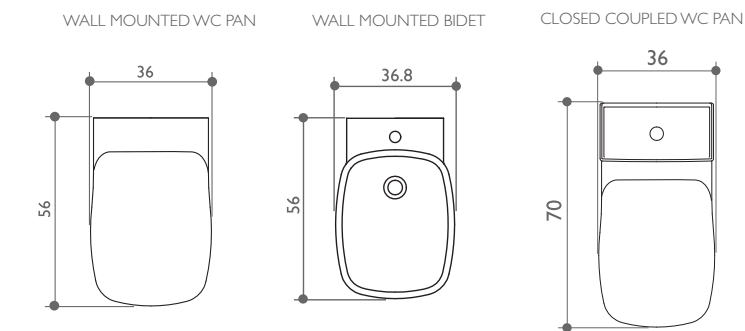
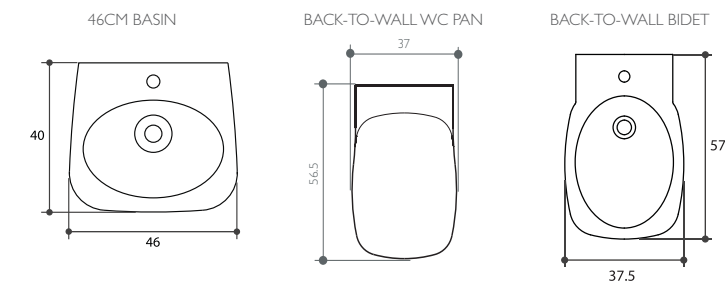
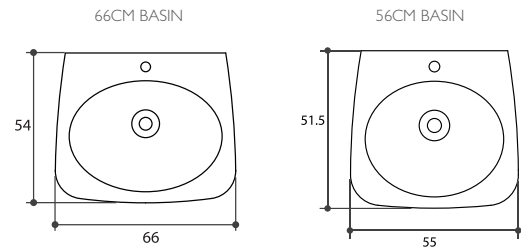

DIMENSIONS

66CM BASIN	Width	cm	66	
	Depth	cm	54	
	Height	cm	16	
	Height from floor	cm	81	
	Tap holes		1	
56CM BASIN	Width	cm	56	
	Depth	cm	51.5	
	Height	cm	16	
	with semi pedestal	cm	32.5	
	Tap holes		1	
46CM BASIN	Width	cm	46	
	Depth	cm	40	
	Height	cm	16	
	with semi pedestal	cm	32.5	
	Height from floor	cm	81	
BACK-TO-WALL WC PAN	Width	cm	37	
	Depth	cm	56.6	
	Height	cm	41	
	BACK-TO-WALL BIDET	Width	cm	37
		Depth	cm	57
Height		cm	45	
Tap holes			1	
WALL MOUNTED WC PAN		Width	cm	36
	Depth	cm	56	
	Height	cm	40	
	WALL MOUNTED BIDET	Width	cm	36.8
Depth		cm	56	
Height		cm	40	
Tap holes			1	
CLOSE COUPLED WC PAN	Width	cm	36	
	Depth	cm	70	
	Height	cm	81.2	

ATOL

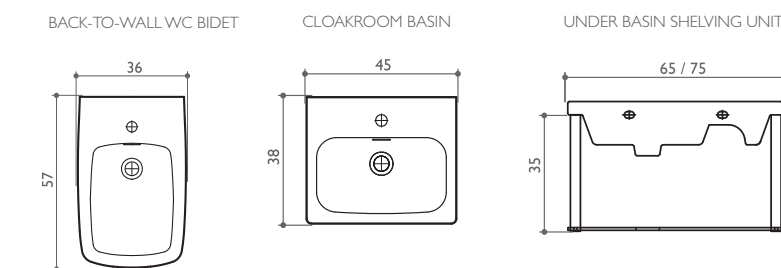
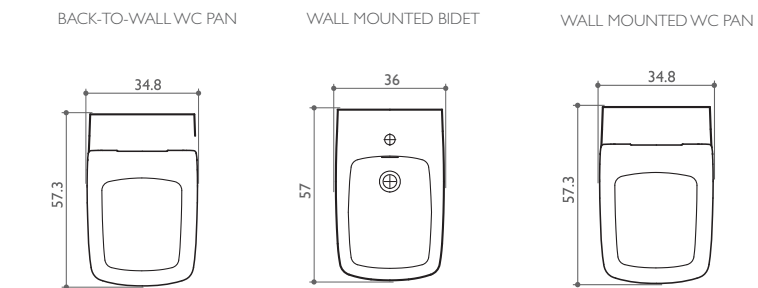
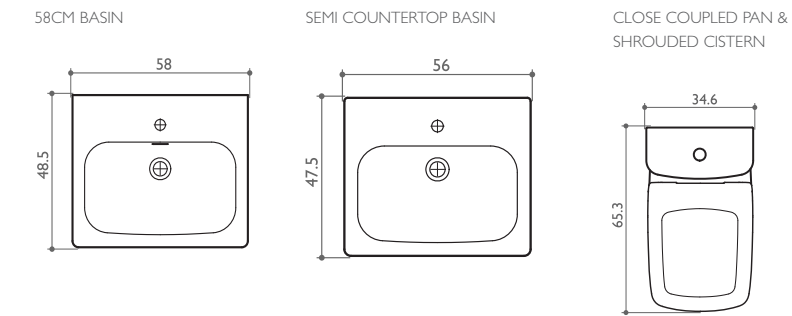
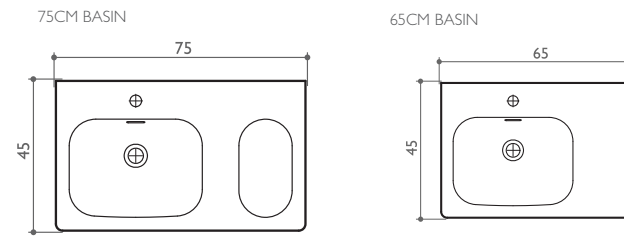

DIMENSIONS

75CM BASIN	Width	cm	75	
	Depth	cm	45	
	Height	cm	16	
	Height from floor	cm	81	
	Tap holes		0/1	
65CM BASIN	Width	cm	65	
	Depth	cm	45	
	Height	cm	16	
	Height from floor	cm	81	
	Tap holes		0/1	
58CM BASIN	Width	cm	58	
	Depth	cm	48.5	
	Height	cm	16	
	Height with pedestal	cm	75.5	
	with semi pedestal	cm	43.7	
SEMI COUNTERTOP BASIN	Width	cm	56	
	Depth	cm	47.5	
	Height	cm	15.5	
	Tap holes		0/1	
	CLOSE COUPLED PAN & SHROUDED CISTERN	Width	cm	34.6
Depth		cm	65.3	
Height		cm	90.8	
BACK-TO-WALL WC PAN	Width	cm	34.8	
	Depth	cm	57.3	
	Height	cm	40	
BACK-TO-WALL BIDET	Width	cm	36	
	Depth	cm	57	
	Height	cm	40	
WALL MOUNTED WC PAN	Width	cm	34.8	
	Depth	cm	57.3	
	Height	cm	32	
WALL MOUNTED BIDET	Width	cm	36	
	Depth	cm	57	
	Height	cm	32	
HEIGHT FROM FLOOR	Height from floor	cm	40	
	Tap holes		1	
	CLOAKROOM BASIN	Width	cm	45
Depth		cm	38	
Height		cm	15.5	
Height from floor		cm	81	
TAP HOLES	Tap holes		0/1	
	ATOL UNDER BASIN SHELVING UNIT	Width	mm	65/75
		Depth	mm	45
Height		mm	35	

BORDO

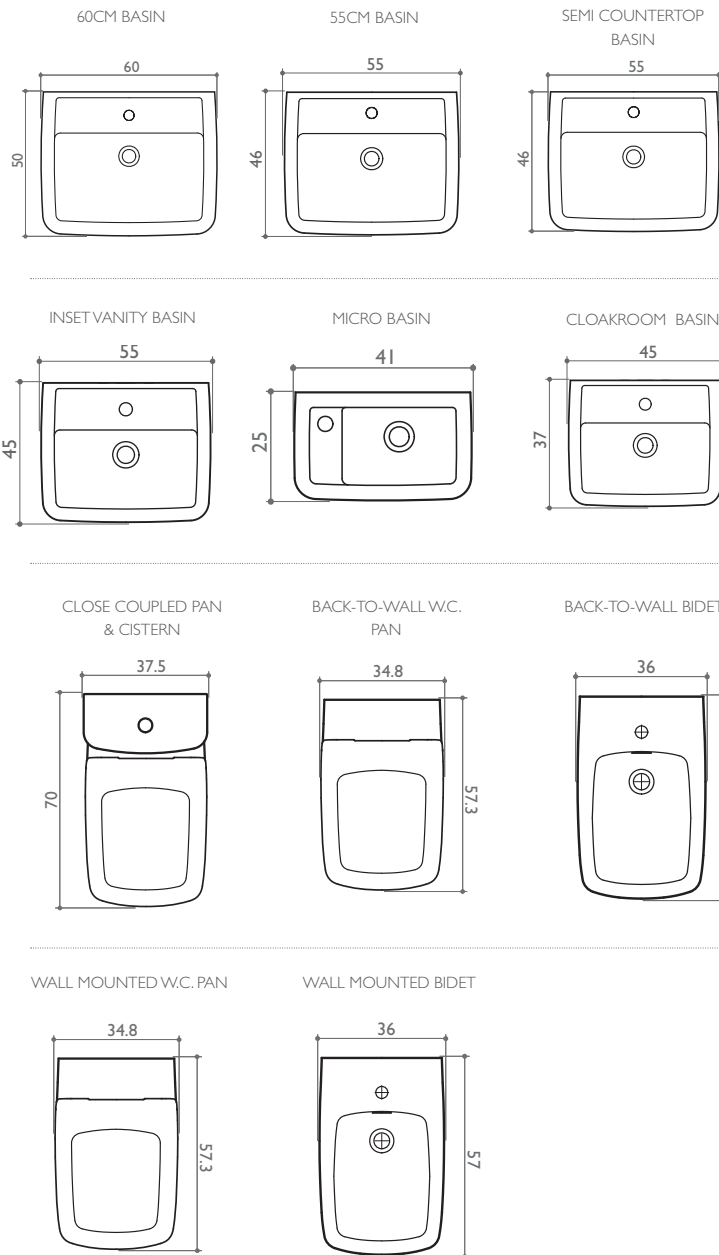

COGNITO

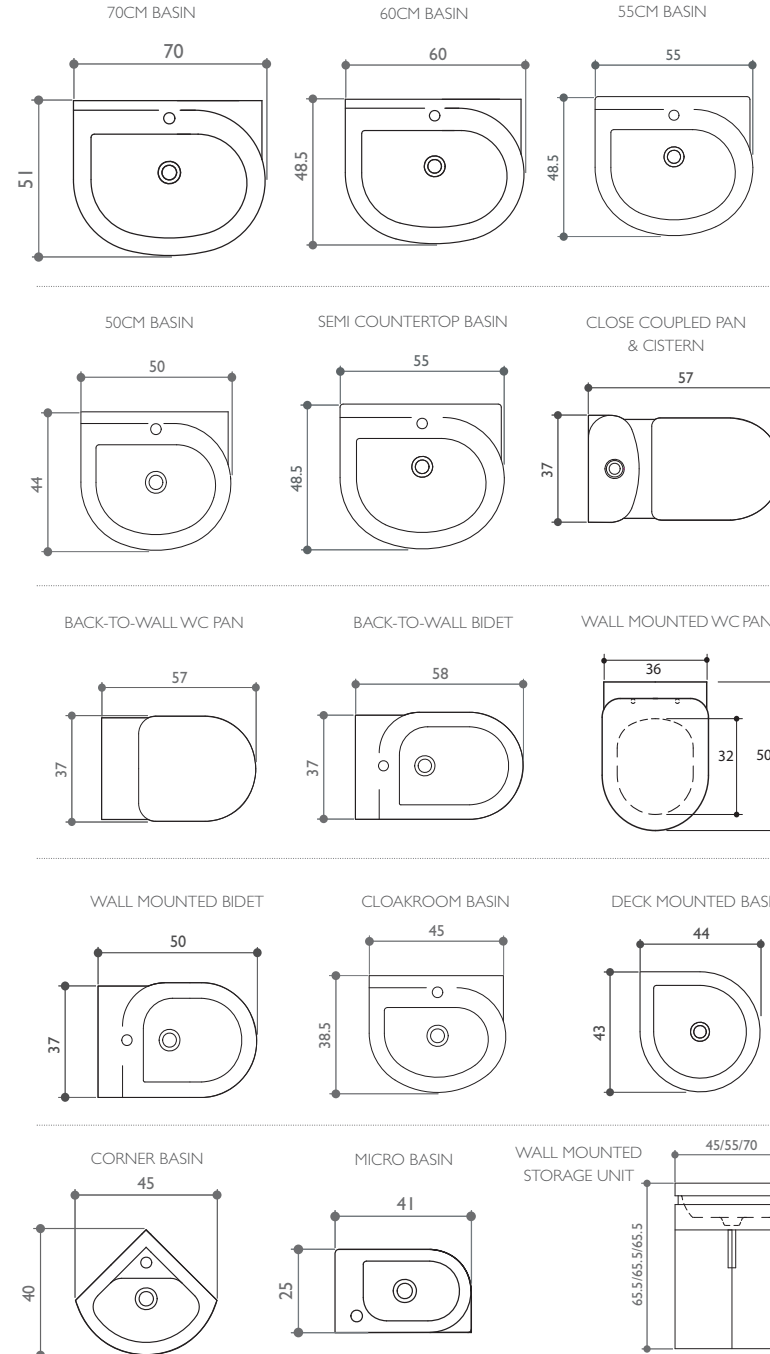

DIMENSIONS

60CM BASIN	Width	cm	60
	Depth	cm	50
	Height	cm	18
	Tap holes		0/1
55CM BASIN	Width	cm	55
	Depth	cm	46
	Height	cm	18
	Tap holes		0/1
SEMI COUNTERTOP BASIN	Width	cm	55
	Depth	cm	46
	Height	cm	18
	Tap holes		0/1
INSET VANITY BASIN	Width	cm	55
	Depth	cm	45
	Height	cm	19
	Tap holes		0/1
MICRO BASIN	Width	cm	41
	Depth	cm	25
	Height	cm	15
	Tap holes		0/1
CLOAKROOM BASIN	Width	cm	45
	Depth	cm	37
	Height	cm	16
	Tap holes		0/1
CLOSE COUPLED PAN & CISTERN	Width	cm	37.5
	Depth	cm	70
	Height	cm	79.5
BACK -TO-WALL W.C. PAN	Width	cm	34.8
	Depth	cm	57.3
	Height	cm	40
BACK -TO-WALL BIDET	Width	cm	36
	Depth	cm	57
	Height	cm	40
	Tap holes		0/1
WALL MOUNTED W.C. PAN	Width	cm	34.8
	Depth	cm	57.3
	Height	cm	32
WALL MOUNTED BIDET	Width	cm	36
	Depth	cm	57
	Height	cm	32

DIMENSIONS

70CM BASIN	Width	cm	70
	Depth	cm	51
	Height with pedestal	cm	83.5
	Height with semi pedestal	cm	49.5
Tap holes		0/1	
60CM BASIN	Width	cm	60
	Depth	cm	48.5
	Height with pedestal	cm	81
	Height with semi pedestal	cm	49.5
Tap holes		0/1	
55CM BASIN	Width	cm	55
	Depth	cm	48.5
	Height with pedestal	cm	80
	Height with semi pedestal	cm	50.5
Tap holes		0/1	
50CM BASIN	Width	cm	50
	Depth	cm	44
	Height with pedestal	cm	78
	Height with semi pedestal	cm	49
Tap holes		0/1	
SEMI COUNTERTOP BASIN	Width	cm	55
	Depth	cm	48.5
	Height	cm	20
Tap holes		0/1	
CLOSE COUPLED PAN & CISTERN	Width	cm	39
	Depth	cm	70
	Height	cm	82
BACK-TO-WALL WC PAN	Width	cm	37
	Depth	cm	57
	Height	cm	34
	Height from floor	cm	41
BACK-TO-WALL BIDET	Width	cm	37
	Depth	cm	58
	Height	cm	39
	Tap holes		1
WALL MOUNTED WC PAN	Width	cm	37
	Depth	cm	50
	Height	cm	33
	Height from floor	cm	41
WALL MOUNTED BIDET	Width	cm	37
	Depth	cm	50
	Height	cm	33.5
	Height from floor	cm	41
Tap holes		1	
CLOAKROOM BASIN	Width	cm	45
	Depth	cm	38.5
	Height	cm	13
	Height with semi pedestal	cm	42
	Tap holes		1
DECK MOUNTED BASIN	Width	cm	44
	Depth	cm	43
	Height	cm	19
	Tap holes		0
CORNER BASIN	Width	cm	45
	Depth	cm	40
	Height	cm	16.5
	Tap holes		1
MICRO BASIN	Width	cm	41
	Depth	cm	25
	Height	cm	15.5
	Tap holes		1
WALL MOUNTED STORAGE UNIT	Width	cm	45/55/70
	Depth	cm	38.4/48.5/51.5
	Height	cm	60.5/60.5/60.5
	Height with basin	cm	65.5/65.5/65.5

REPUBLIC

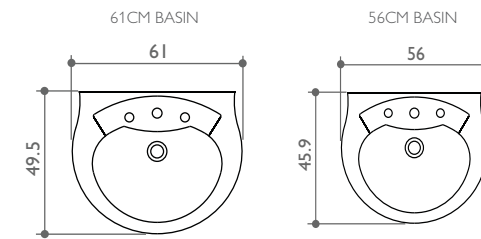

CLOSE COUPLED PAN & CISTERN

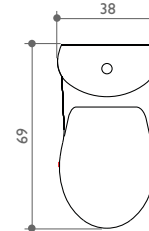

BACK-TO-WALL WC PAN

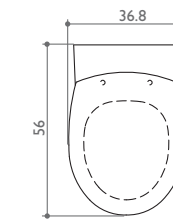

BACK-TO-WALL BIDET

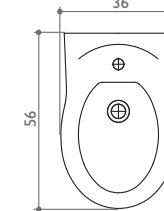

WALL MOUNTED WC PAN

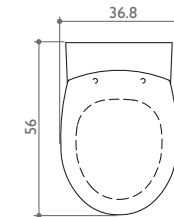

WALL MOUNTED BIDET

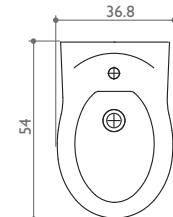

CLOAKROOM BASIN

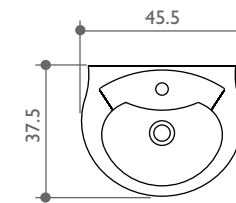

SEMI COUNTERTOP BASIN

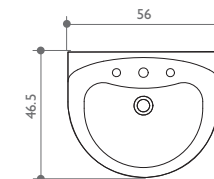

CORNER BASIN

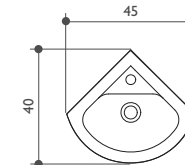

DIMENSIONS

61CM BASIN	Width	cm	61
	Depth	cm	49.5
	Height with pedestal	cm	82.5
	With semi pedestal	cm	48.5
	Tap holes		1/3
56CM BASIN	Width	cm	56
	Depth	cm	45.9
	Height with pedestal	cm	82.5
	With semi pedestal	cm	48.5
	Tap holes		1/3
CLOSE COUPLED PAN & CISTERN	Width	cm	38
	Depth	cm	69
	Height	cm	79
BACK-TO-WALL WC PAN	Width	cm	36.8
	Depth	cm	56
	Height	cm	41
BACK-TO-WALL BIDET	Width	cm	36
	Depth	cm	56
	Height	cm	40
	Tap holes		1
WALL MOUNTED WC PAN	Width	cm	36.8
	Depth	cm	56
	Height	cm	40
	Height from floor	cm	43
WALL MOUNTED BIDET	Width	cm	36.8
	Depth	cm	54
	Height	cm	40
	Height from floor	cm	40
	Tap holes		1
CLOAKROOM BASIN	Width	cm	45.5
	Depth	cm	37.5
	Height	cm	17.5
	With pedestal	cm	83.5
	With semi pedestal	cm	42.5
	Tap holes		1
SEMI COUNTERTOP BASIN	Width	cm	56
	Depth	cm	46.5
	Height	cm	21.5
	Tap holes		1/3
CORNER BASIN	Width	cm	45
	Depth	cm	40
	Height	cm	16.5
	Tap holes		1

REPUBLIC NOVO

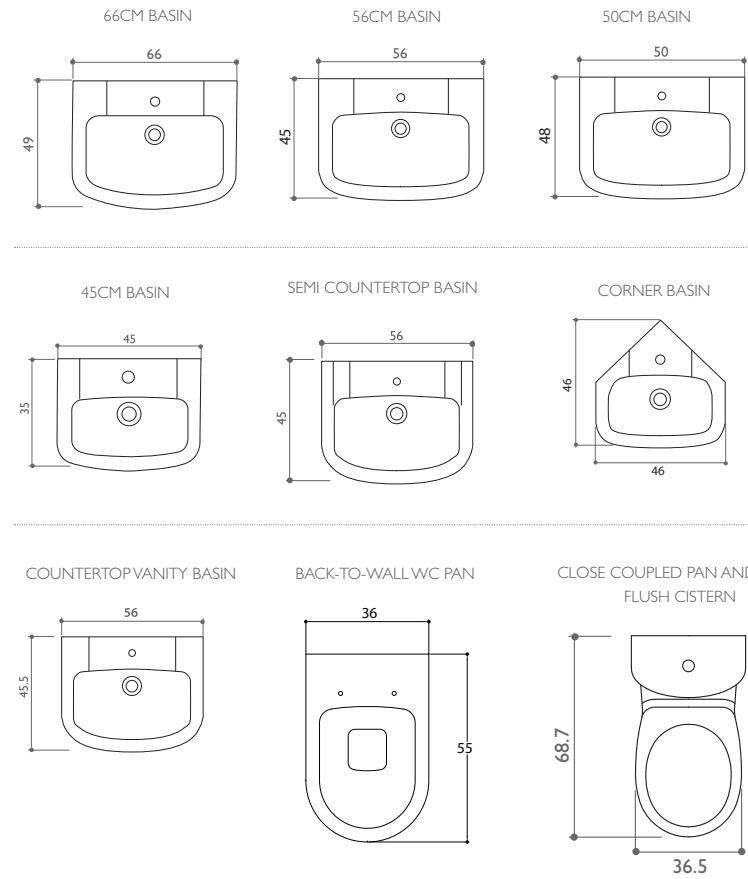

CORINTO

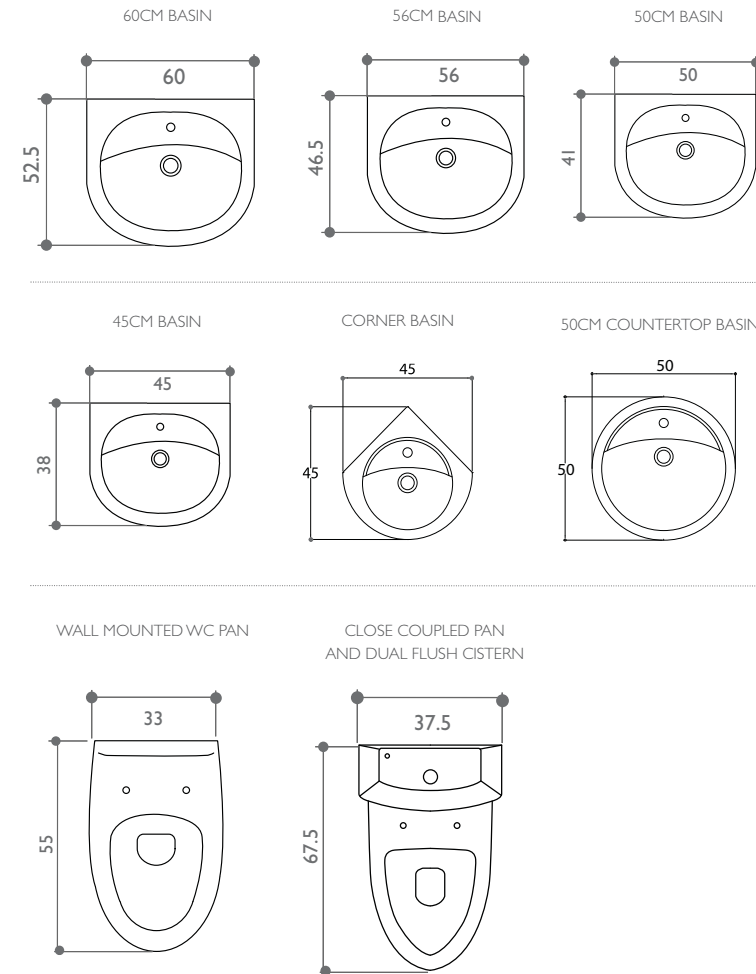

DIMENSIONS			
60CM BASIN	Width	cm	60
	Depth	cm	52.5
	Height with pedestal	cm	84
	With semi pedestal	cm	48.5
	Tap holes		1
56CM BASIN	Width	cm	56
	Depth	cm	46.9
	Height with pedestal	cm	84.5
	With semi pedestal	cm	48.5
	Tap holes		1
50CM BASIN	Width	cm	50
	Depth	cm	41
	Height with pedestal	cm	84
	With semi pedestal	cm	48.5
	Tap holes		1
45CM BASIN	Width	cm	45
	Depth	cm	38
	Height with pedestal	cm	82.5
	With semi pedestal	cm	48.5
	Tap holes		1
CORNER BASIN	Width	cm	45
	Depth	cm	54
	Tap holes		1
50CM COUNTERTOP BASIN	Width	cm	50
	Depth	cm	50
	Tap holes		1
WALL MOUNTED WC PAN	Width	cm	33
	Depth	cm	55
	Height	cm	40
CLOSE COUPLED PAN & CISTERN	Width	cm	37.5
	Depth	cm	67.5
	Height	cm	79

GUARANTEES

JACUZZI BATHROOM PRODUCTS

PRODUCT GROUP	GUARANTEE
Sanitaryware	Lifetime
Baths	Lifetime
Whirlpool Systems	2 Years
Shower Enclosures (excluding seals)	10 Years
Over Bath Screens	10 Years
Brassware (excludes valves, rings & seals)	10 Years
Toilet Seat Soft-Close Mechanism	10 Years
Geberit Cistern Fittings	5 Years
Accessories	2 Years
Glass Protection Coating	2 Years
Toilet Seats and Hinges	2 Years
Jacuzzi Bathroom Furniture	2 Years
Steam Cabins	2 Years
Combination Units	2 Years
Showering Controls and Tap Valves	2 Years

Your new Jacuzzi® bathroom product comes with a re-assuring guarantee. Registering your new product on-line gives you automatic membership to the Jacuzzi® Owners Club offering you additional warranty to those listed above.

All guarantees are against manufacturing defect.

Consumers should register their guarantees either on-line, or by completing the form contained within the packaging of their product.

As we're sure you will appreciate a brochure can only really give a flavour of our products – touch and feel are equally important and Jacuzzi® products are even more stunningly beautiful when experiencing them first hand. That's why we highly recommend that you visit your local Jacuzzi® Bathroom Specialist, who will not only assist with planning your bathroom, but will advise on all the practical requirements for your choice of bathroom.

You can rest assured that all Jacuzzi products have been manufactured to the highest standards and as you would expect, all the Jacuzzi bathroom products carry excellent guarantees, including a lifetime guarantee on our Sanitaryware and baths. (see above)

For more details on our guarantees and to find your nearest showroom please visit our website:- www.jacuzzi.co.uk

JACUZZI® FOR YOU

Make the most of your Jacuzzi bathroom or hot tub with our range of accessories, wellbeing and cleaning products.

Visit Jacuzzi for You at www.jacuzzi.co.uk to see the full choice on offer, from aromatherapy oils for your whirlpool bath to special hot tub cleaning products or alternatively call 01782 717175.

WELL BEING – a range of oils and essences to give you the ultimate bathing or showering experience.



ACCESSORIES – practical and beautiful additions to your bathroom or hot tub.



CARE – stay beautiful with our approved cleaning and maintenance products to help you take the very best care of your bathroom or hot tub.

